

InPro Decorative Surfaces



Shower Bases

Available in numerous colors, shower bases are easily customizable to fit size and drain placement needs. Featuring textured surface to reduce risk of slips and falls, shower bases are also available with an ADA compliant front transitional edge. p.246

Vanity & Counter Tops
Aesthetically pleasing and exceedingly functional, InPro Decorative surfaces are the ideal surfacing solution for Vanity and Counter Top applications. BioPrism™ solid surface is NSF-51 approved. p.258



Shower & Tub Surrounds

Create an easy-to-maintain shower or bath system using InPro Decorative Surfaces. Non-porous, these surrounds will not promote the growth of mold, mildew, or bacteria. p.250



Decorative Panels
InPro Decorative Panels add a more custom look to vertical applications. Made from BioPrism™ solid surfaces, these panels are durable, easy to maintain and environmentally friendly. Ideal applications include wainscoting, shower and bath surrounds, backsplashes and more! p.252



Grab Bars

Reduce the risk of injury in bathrooms with grab bars and safety supports. With an in-depth offering including multiple sizes, angles and colors, there is a solution to accommodate your project's need. p.255



Wall Base

Ideal for high traffic areas, BioPrism™ solid surface wall base has been tested to withstand even the harshest commercial environments. p.253

Window Sills & Decorative Trim

Moisture resistant and visually appealing, BioPrism™ solid surface window sills are durable and easy to maintain.

Available in two standard profiles, BioPrism™ solid surface decorative trim is ideal as an accent piece, chair rail or crown molding. p.253



p. 242
What is BioPrism™

p.243
What is Lippert®

p. 244
Vertical Wall
Panels

p.246
Shower Bases

p. 250
Shower & Tub
Surrounds

p. 252
Decorative Panels

p. 254
Bath
Accessories

p.258
Vanity Tops

p. 260
Vanity Sink
Styles & Edges

p. 262
Countertop Sink
Styles & Edges

p. 263
Sheet Stock
Optimization

p. 264
Scratch & Stain
Resistance

p. 265
Custom
Fabrication

p. 266
Color Palette

p. 268
Accessories

Decorative
Surfaces

What is BioPrism™?

| SOLID SURFACE |

BioPrism™ Solid Surface is an environmentally friendly material. It is renewable and easily repaired, offering low maintenance and easy cleaning. BioPrism is long-lasting, resisting chips, cracks and stains.

- Versatile surface is perfect for a number of applications including bathrooms, corridors, food service areas, reception areas and clean rooms
- Surface is easy to clean, non-porous and does not promote the growth of mold, mildew or bacteria
- Contains a proprietary blend of acrylic and polyester resins, specially formulated for commercial environments offering the highest level of chemical resistance in a decorative surface
- Independently tested to withstand greater impact resistance than leading brands (izod impact, notched test)
- All colors available in ¼", and ½" thicknesses; custom sheet sizes available up to 48" x 144" (see p.52)
- Meets National Sanitation Foundation (NSF)/ANSI Standard 51
- Backed by a 10-year limited product warranty
- Class 1A Fire Rating
- Izod impact strength is an ASTM standard method of determining impact strength. A notched sample is generally used to determine impact strength. A higher number indicates greater impact strength. BioPrism solid surface has received a score of .36.

BioPrism Solid Surface contains **resins** which are formulated using **recycled and renewable raw materials**.

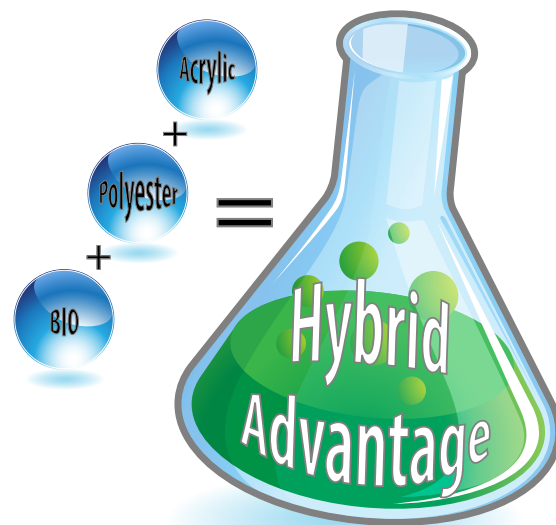

Learn more about BioPrism Sheet Optimization to lower costs and reduce waste on p.263





What is Lippert®?

| CULTURED MARBLE |

- Best utilized in bathroom applications as vanity tops, shower/tub surrounds, and wall panels
- Hand-crafted and hand-veined quality for over 40 years
- One of the largest selection of cultured marble colors in the industry to allow for design flexibility
- Standard gloss finish enables the pattern to shine
- Optional satin finish gives the appearance of a solid surface product
- Tested and certified per ANSI standards to ensure product longevity
- Backed by a 10-year residential limited product warranty (1 year for crazing), 5-year limited product warranty for commercial use
- Made in the USA!



Add elegance to any décor with Lippert® Cultured marble.

Hand-crafted and hand-veined for over 40 years. Lippert has one of the largest color selections in one industry.

p. 242
What is BioPrism™

p.243
What is Lippert®

p. 244
Vertical Wall
Panels

p.246
Shower Bases

p. 250
Shower & Tub
Surrounds

p. 252
Decorative Panels

p. 254
Bath
Accessories

p.258
Vanity Tops

p. 260
Vanity Sink
Styles & Edges

p. 262
Countertop Sink
Styles & Edges

p. 263
Sheet Stock
Optimization

p. 264
Scratch & Stain
Resistance

p. 265
Custom
Fabrication

p. 266
Color Palette

p. 268
Accessories

Decorative
Surfaces

Wall Panel System

| BIOPRISM™ SOLID SURFACE |

Create a **continual appearance** using available accessories.



- Non-porous BioPrism panels create sterile surgical suites and exam rooms or decorative, clean and protective wall cladding
- Coordinate interiors with Solid Surface colors (p. 266 *1/4" preferred for wall panels*)
- Provide a continual appearance with available accessories including corner molding, batten strips and perimeter trim
- Add a decorative element by incorporating shapes or logos in the wall panels

Why Choose BioPrism Wall Panels?

- Custom sheet sizes: Up to 48" x 144"
- Fewer field seams reduce installation time, cost and waste
- Sheet thickness: all colors available in 1/4", and 1/2" in matte, semi-gloss or gloss finishes
- Optimized sheet sizes are delivered manufacturer-direct to project

Standard Sizes

Thickness: 1/4", 1/2"
Widths: 30", 36", 48"
Lengths: 6', 8', 10', 12'

Wavy Edge

Request a wavy edge on your next wall panel order. This unique s-curve edge creates a flush seam as two panels are brought together. The complementary curves fit together to maintain a flat seam where the wall may fluctuate.

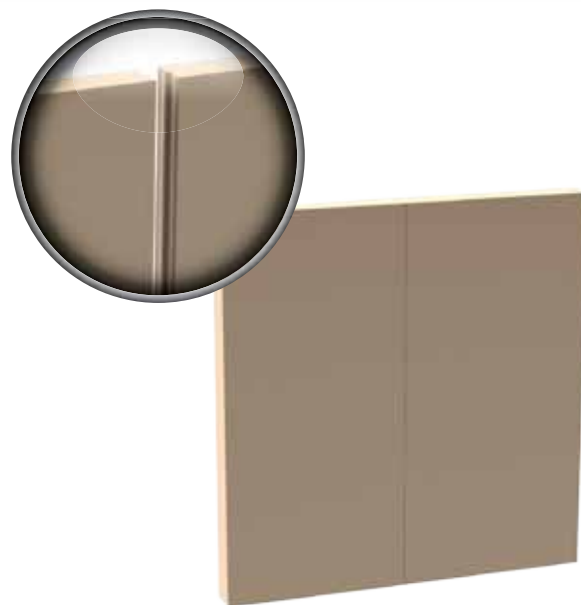



Vertical Wall Panels

| BIOPRISM™ SOLID SURFACE |



A. Large Trim: Create a decorative element, by adding trim to complement the rest of your décor



E. Batten Strip: Strengthen and cover wall panel seams with a decorative look



B. Beadboard: Extend our popular pattern from our vinyl wall products, now also available on our solid surface



F. Small trim: Insert a decorative element with this architectural trim used as a panel cap, or framework for any wall panel



C. Wall Base: Protect walls from scuffing by completing the area where the floor and wall meet with BioPrism Solid Surface material



G. Outside Corner: Reinforce your corners with an impact resistant solid surface. Choose the same color or a complementary color to highlight the corner



D. Inside Corner: Provide extra protection and a smooth transition where walls and corners meet



H. Panel Molding: Add a thicker picture-frame style edge to any wall panel

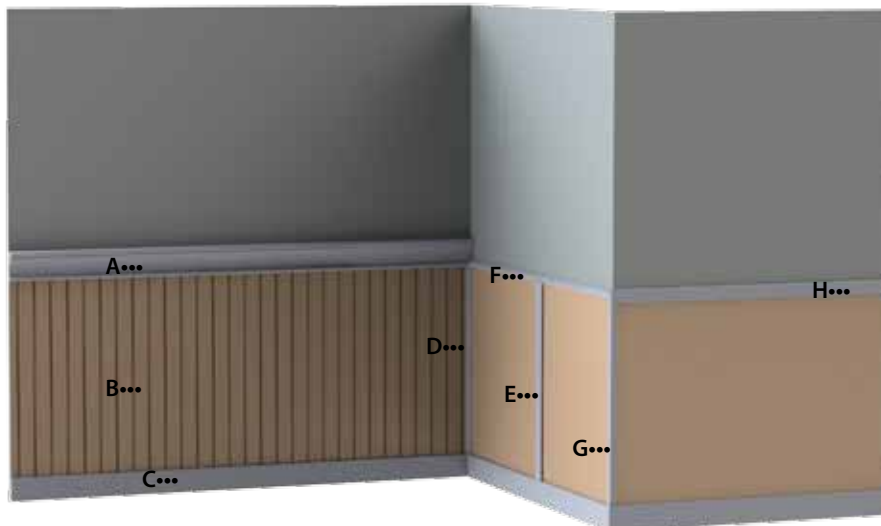

Shower Bases

| BIOPRISM™ SOLID SURFACE |



Custom designed
to fit your needs.

**ADA
Compliant**

Non-skid surface helps prevent
slips and falls

- Solid pour of non-porous, homogeneous material. Solid surface throughout makes the receptor stronger for commercial use verses less substantial, traditional receptors that are backfilled with foam
- Custom entryway options. Select from a standard beveled transitional edge, curb design or flush roll-in for ADA-compliant showers
- Custom made to fit your size requirements and drain location at no extra cost. Also choose a custom sized drain hole – sizes can meet InPro drain standards or accommodate another manufacturer's drain
- Select your desired water barrier height
- Includes an Oatey® brand drain in chrome finish

Standard Shower Base Sizes

Square

32" x 32"
36" x 36"
Neo Angle
36"
42"

Rectangular

32" x 48"
36" x 48"
42" x 48"
32" x 60"
36" x 60"

Double Threshold

36"
Custom (including ADA)
88" x 112" with Center Drain
90" x 66" maximum - offset Drain
Drain minimum 7" from edge

Rectangular

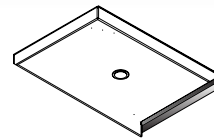

Double Threshold

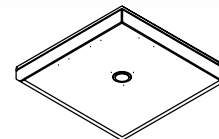

Neo Angle

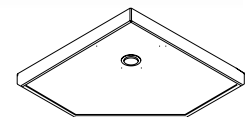

BioPrism Solid Surface Receptors	Leading Competitive Brand
Solid fill of solid surface material, minimum 3/4" thick	Thermoformed, 1/2" thick
10 year warranty	1 year warranty
Non-skid surface standard	Smooth surface standard
<p>SECTION A-A SCALE 1 : 8</p>	<p>Solid Foam Filled</p>

p. 242
What is BioPrism™

p.243
What is Lippert®

p. 244
Vertical Wall
Panels

p.246
Shower Bases

p. 250
Shower & Tub
Surrounds

p. 252
Decorative Panels

p. 254
Bath
Accessories

p.258
Vanity Tops

p. 260
Vanity Sink
Styles & Edges

p. 262
Countertop Sink
Styles & Edges

p. 263
Sheet Stock
Optimization

p. 264
Scratch & Stain
Resistance

p. 265
Custom
Fabrication

p. 266
Color Palette

p. 268
Accessories



Shower Bases

| BIOPRISM™ SOLID SURFACE |



Custom Curb and Drain Locations

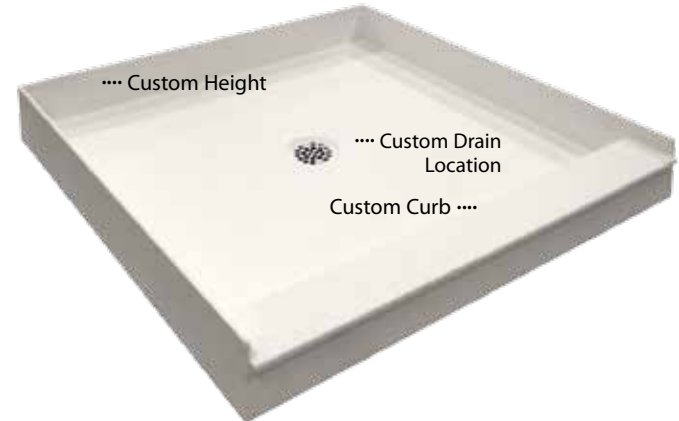

NEW! BioPrism™ Duo-Tone Shower Base

- Define transitional edge with the use of contrasting threshold color to aid sight-impaired or bariatric patients
- Comprehensive color offering allows for easy incorporation into project design
- Contrasting threshold is integrally bonded to solid surface shower base to create a durable, easy-to-maintain surface
- Available edge options include standard curb edge or ADA compliant beveled transitional edge
- Integral water barrier prevents water seepage behind or under shower receptor
- Non-skid, textured surface helps prevent slips and falls-the coefficient of friction tops the competition

2,400lbs



BioPrism Solid Surface shower bases have passed the ANSI Z124.1.2-2005 test where the fixture being tested is subjected to loads in excess of 300 pounds. In fact, the BioPrism shower base under this test, had reached almost 2,400 pounds!

p. 242
What is BioPrism™

p.243
What is Lippert®

p. 244
Vertical Wall
Panels

p.246
Shower Bases

p. 250
Shower & Tub
Surrounds

p. 252
Decorative Panels

p. 254
Bath
Accessories

p.258
Vanity Tops

p. 260
Vanity Sink
Styles & Edges

p. 262
Countertop Sink
Styles & Edges

p. 263
Sheet Stock
Optimization

p. 264
Scratch & Stain
Resistance

p. 265
Custom
Fabrication

p. 266
Color Palette

p. 268
Accessories

Shower Bases

| LIPPERT® CULTURED MARBLE |

Integral water barrier

prevents water seepage behind
or under shower receptor

- Standard shower bases feature a non-skid, textured surface to help prevent slips and falls
- ADA-compliant option with a beveled transitional edge allows for easy access without creating a water hazard
- Available in the complete Lippert Cultured Marble color palette (p.267)
- Custom made to fit your **size requirements** and drain location at no extra cost. Also choose a custom sized drain hole – sizes can meet InPro standards or accommodate another manufacturer's drain

Standard Shower Base Sizes

Square

32" x 32"

36" x 36"

Neo Angle

36"

42"

Rectangular

32" x 48"

36" x 48"

42" x 48"

32" x 60"

36" x 60"

Double Threshold

36"

Custom (including ADA)

88" x 112" with Center Drain

90" x 66" maximum - offset drain
Drain minimum 7" from edge

Rectangular

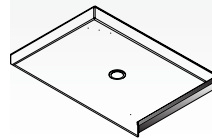

Double Threshold

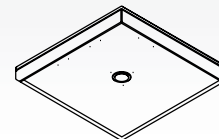

Neo Angle

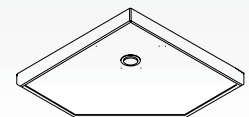

**ADA
Compliant**

Decorative
Surfaces



Most Choices in Decorative Surfaces



p. 242
What is BioPrism™

p.243
What is Lippert®

p. 244
Vertical Wall
Panels

p.246
Shower Bases

p. 250
Shower & Tub
Surrounds

p. 252
Decorative Panels

p. 254
Bath
Accessories

p.258
Vanity Tops

p. 260
Vanity Sink
Styles & Edges

p. 262
Countertop Sink
Styles & Edges

p. 263
Sheet Stock
Optimization

p. 264
Scratch & Stain
Resistance

p. 265
Custom
Fabrication

p. 266
Color Palette

p. 268
Accessories

Shower & Tub Surrounds

| BIOPRISM™ SOLID SURFACE |



Dress up your shower or bath with
BioPrism™ Solid Surface surrounds

Showers

- Optional non-skid, textured, solid surface base helps to prevent slips and falls: Sold Separately

Tub Surrounds

- Custom sized panels available
- Install a surround in less time than tile. No grout that cracks, leaks or harbors mold/mildew
- ¼" solid surface panels provide lighter weight surface surrounds
- Optional soap dish or soap shelf available

Tub Decks

- Enclose your whirlpool tub with a custom solid surface tub deck

A.

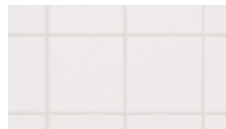

Decorative Panel: Choose from a variety of smooth, tile or beadboard patterns in any standard BioPrism color

B.



Inside Covered Corner: Provide extra protection and a smooth transition where walls and corner meet

C.



Perimeter Trim: Dress up the solid surface with perimeter trim pieces



- Recessed Soap Dish
- Soap Shelf
- Small Soap Dish
- Large Soap Dish

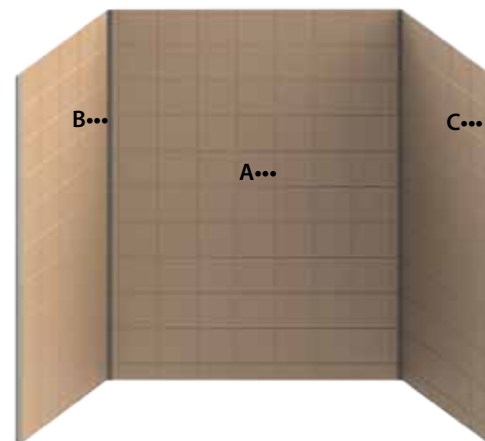

Decorative
Surfaces

Shower & Tub Surrounds

| LIPPERT® CULTURED MARBLE |

Lippert Cultured Marble has been shaping the future of beautiful bathrooms for over a quarter century

Showers

- Optional non-skid textured cultured marble shower base helps prevent slips and falls; sold separately

Tub Surrounds

- Custom sized panels available
- Install a surround in less time than tile. No grout that cracks, leaks or harbors mold/mildew
- 3/8" cultured marble panels provide lighter weight surface surrounds

Tub Decks

- Enclose your whirlpool tub with a custom cultured marble tub deck



Small Recessed Caddy

- Optional corner molding, batten strip trim, corner caddy, soap caddy and recessed soap/shampoo caddy also available

Gloss finish standard. Satin finish optional

Corner Shower Seat

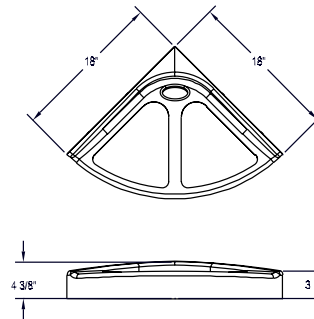

Batten Strip

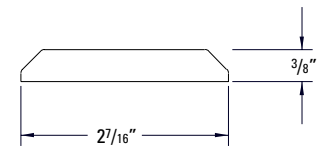

Inside Corner Molding

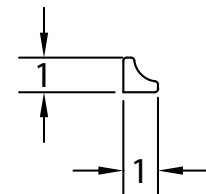

Corner Caddy

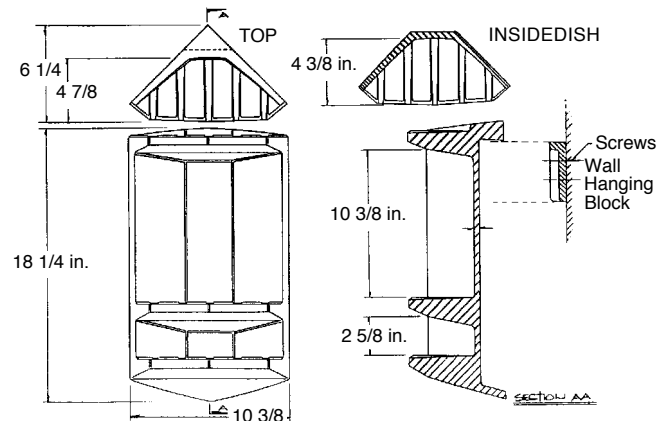

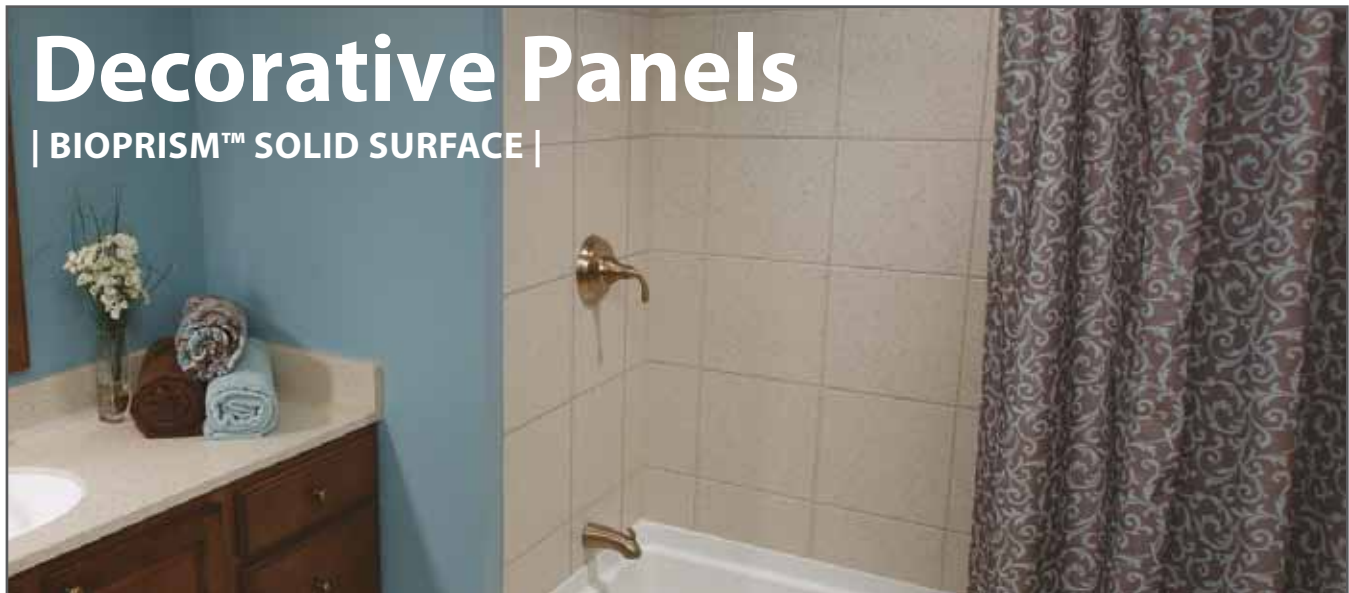

Decorative Panels

| BIOPRISM™ SOLID SURFACE |

- Add BioPrism™ Decorative Panels on vertical surfaces, such as shower areas, lobby desks and nurse's stations to create a decorative and unique appearance. If you can draw it, we can rout it!
- Sheet is routed to give a tile-like appearance, without seams or grout, for a sanitary surface
- With colors in BioPrism ranging from inviting neutrals to vitalizing patterns, you can easily complement any interior (p. 266)
- Custom items have a maximum size of 62" x 96", or 48" x 144"

Create a **unique appearance** with Decorative Panels.

Save Time vs. Tile Installation

67% Faster!

Patterns

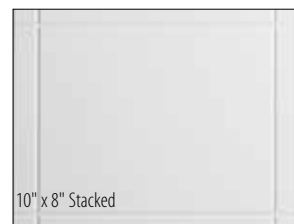
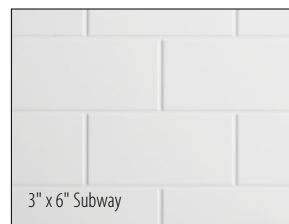
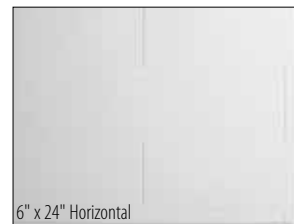
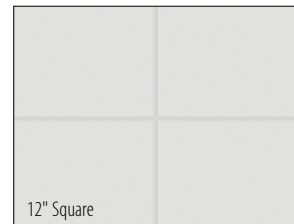
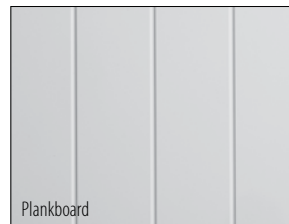
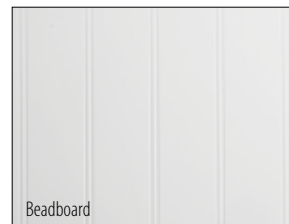
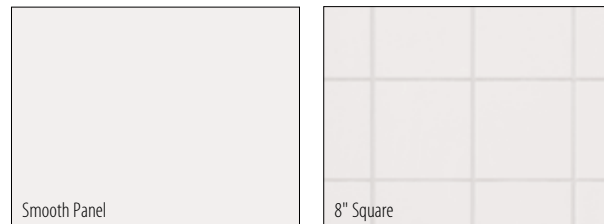

Listellos

5" height



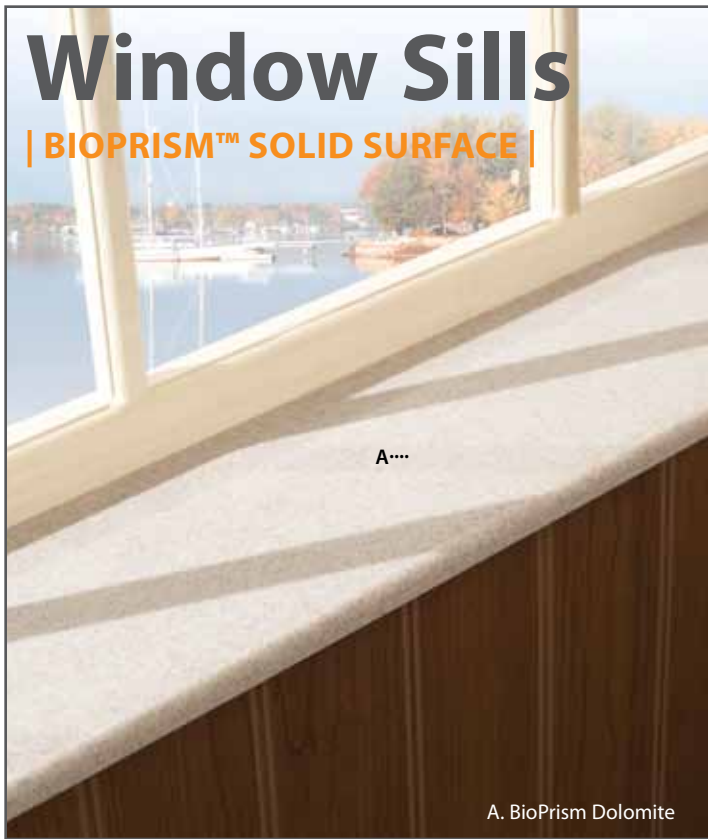

A perfect alternative to plastic laminate sills, **solid surface sills will not delaminate, rot, fade or warp** due to the effects of the weather.

BioPrism Custom Sizes

Thicknesses: 1/2" or 3/4" available flat or with a drop edge
Maximum Length: 144"



BioPrism Quick Ship Window Sills!

1/2" thick
Max Depth: 12"
Max Quantity: 20



Create a decorative element by adding **BioPrism trim as a chair rail, accent piece or crown molding** to a wall, ceiling or elevator.

- Two standard profiles available (small and large); or, design your own custom profile!
- Five neutral solid colors available

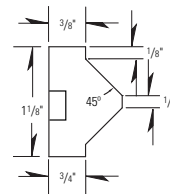

BioPrism Taupe
Small Trim Piece

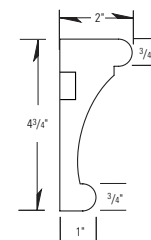

BioPrism Antique White
Large Trim Piece

p. 242
What is BioPrism™

p.243
What is Lippert®

p. 244
Vertical Wall
Panels

p.246
Shower Bases

p. 250
Shower & Tub
Surrounds

p. 252
Decorative Panels

p. 254
Bath
Accessories

p.258
Vanity Tops

p. 260
Vainity Sink
Styles & Edges

p. 262
Countertop Sink
Styles & Edges

p. 263
Sheet Stock
Optimization

p. 264
Scratch & Stain
Resistance

p. 265
Custom
Fabrication

p. 266
Color Palette

p. 268
Accessories

Bath Accessories

BIM
READY



- Superior non-slip surface helps residents, patients and guests obtain a firmer grip
- 1¼" grab bar diameter meets ADA compliance and allows for a better grip for women and children
- Provides a warm touch surface (white and ivory only)
- Available in stainless steel, white or ivory; other colors and grab bar styles available upon request
- Offers a secure and safe installation by giving the installer the flexibility to choose from 11 mounting holes on the mounting flange white (9 mounting holes for Stainless Steel)
- Folding safety supports offers stability when needed. Can be easily folded out of the way
- Bath seats allow for safety while bathing and getting in and out of the tub or shower
- Complete the bathroom with a variety of accessories
- Custom sizes and configurations available

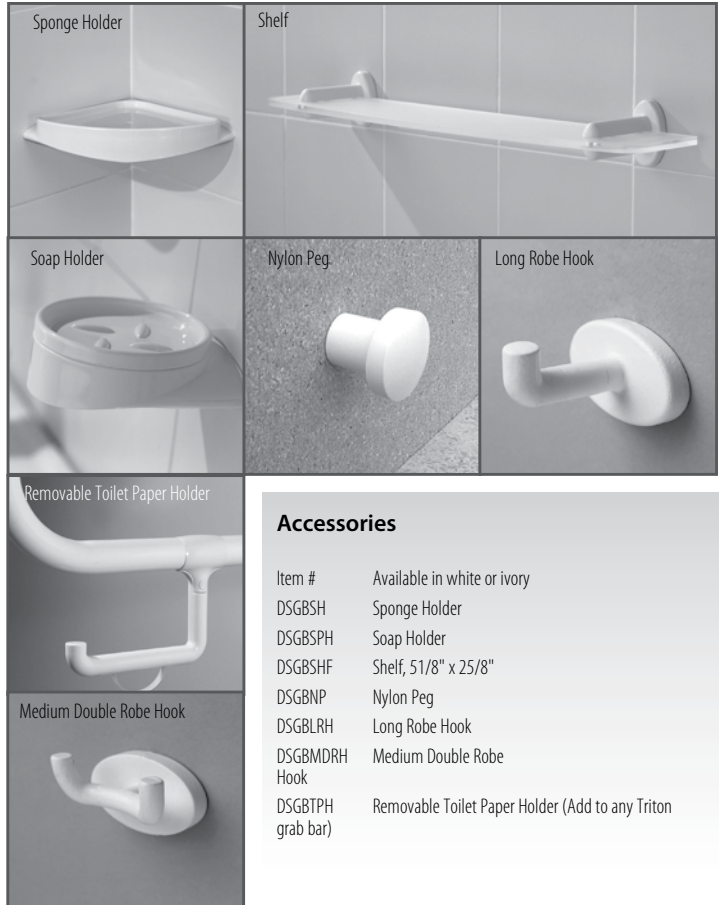

Due to the printing process, colors may vary. For more accurate color selection, please request samples. Color of final product may vary slightly from sample. Warranty excludes color variation from sample to final product. Dark colors may require additional maintenance.

Decorative
Surfaces

Bath Accessories

| GRAB BARS |



Corner Grab Bar ■

Item Numbers:

- DSGBCS1ADA Corner Grab Bar, 24" x 26"
- DSGBCS2ADA Corner Grab Bar, 22¹/₂" x 42¹/₄"

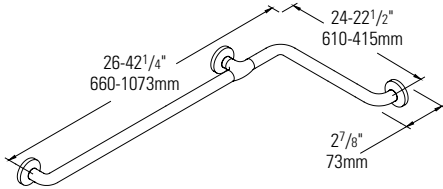

Straight Grab Bar ■

Item Numbers:

- DSGB12ADA Straight Grab Bar, 12" length
- DSGB16ADA Straight Grab Bar, 16" length
- DSGB18ADA Straight Grab Bar, 18" length
- DSGB24ADA Straight Grab Bar, 24" length
- DSGB30ADA Straight Grab Bar, 30" length
- DSGB32ADA Straight Grab Bar, 32" length
- DSGB36ADA Straight Grab Bar, 36" length
- DSGB42ADA Straight Grab Bar, 42" length
- DSGB48ADA Straight Grab Bar, 48" length

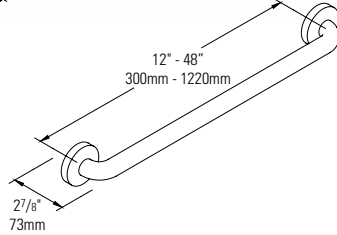

ADA Angled Grab Bar White Only ■

Item Numbers:

- DSGBABADA Angled Grab Bar

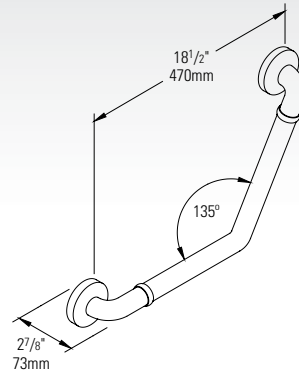

Angled Grab Bar ■

Item Numbers:

- DSGBC185B Angled Grab Bar, 18¹/₂"

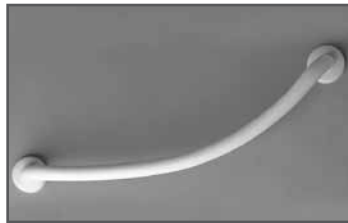
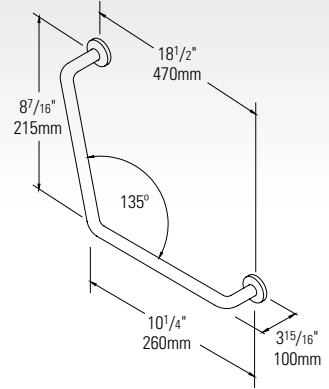

Curved Grab Bar ■

Item Numbers:

- DSGBCBR Right Curved Grab Bar, 25⁵/₈"
- DSGBCRL Left Curved Grab Bar, 25⁵/₈"

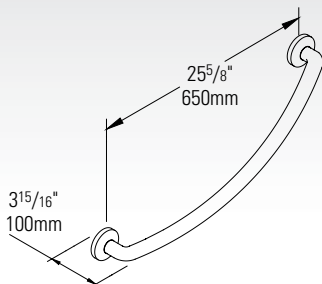

Vertical Grab Bar ■

Item Number:

- DSGBVSHADA Vertical Grab Bar with sliding hand shower holder, 44¹/₈" length

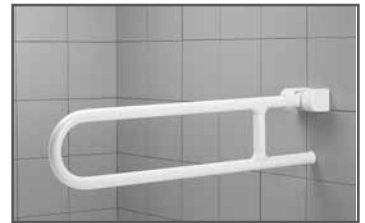
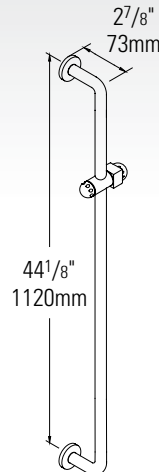

Rotating Folding Safety Support ■

Item Numbers:

- DSGBFDSSS Folding Safety Support, 33¹/₂"

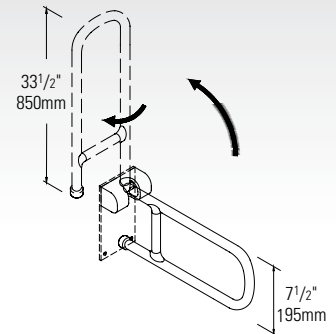

Bath Accessories

| GRAB BARS |



**ADA
Compliant**

Vertical & Horizontal Grab Bar ■

Item Numbers:

DSGBVHSADA Vertical and Horizontal Grab Bar,
30" x 33 3/4" x 33 3/4"

DSGBHS-SN Hand Shower, Satin Nickel

DSGBFH-SN Flex Hose, Satin Nickel

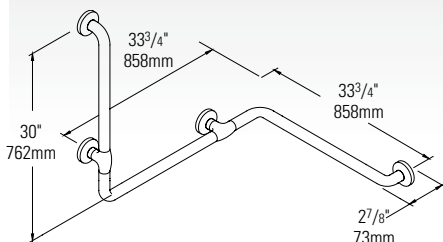

Fixed Side Safety Support ■

Item Numbers:

DSGBFSS Fixed Side Safety Support,
33 1/2"

DSGBFSSPH Fixed Side Safety Support w/ paper roll holder,
33 1/2"

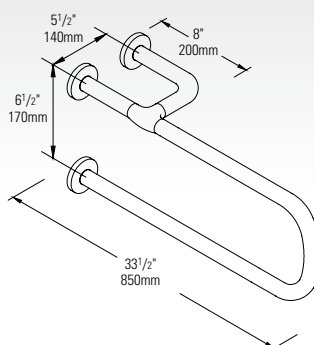

Rotating Safety Support ■

Item Numbers:

DSGBFDSSS Folding Safety Support, 33 1/2" length

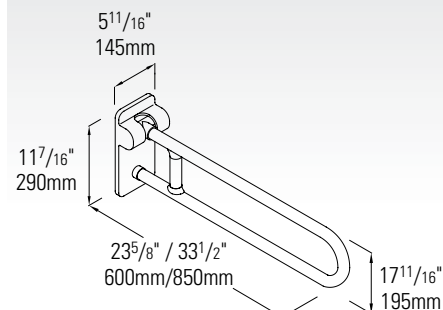

**ADA
Compliant**

L-Shaped Grab Bar ■

Item Numbers:

DSGBLR1ADA Right L-Shaped Grab Bar,
24" x 12"

DSGBLL1ADA Left L-Shaped Grab Bar,
24" x 12"

DSGBLR2ADA Right L-Shaped Grab Bar,
36 1/8" x 17 3/4"

DSGBLL2ADA Left L-Shaped Grab Bar,
36 1/8" x 17 3/4"

DSGBLRHADA Right L-Shaped Grab Bar with
Hand Shower Holder, 46" x 24"

DSGBLLHADA Left L-Shaped Grab Bar with
Hand Shower Holder, 46" x 24"

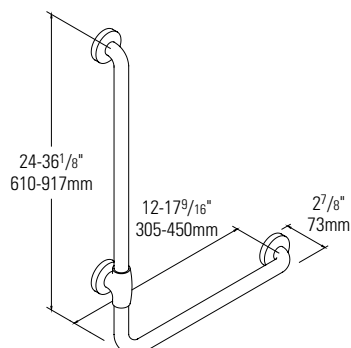

Double Folding Seat ■

Item Numbers:

DSGBDFSADA ADA Double Folding Seat, 21 1/2" x 26"

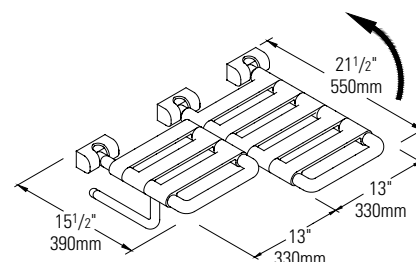

Bath Accessories

| STAINLESS STEEL GRAB BARS |



Wall to Floor Grab Bar

DSGBFWADA-ST5
38 9/16" height
Available in stainless steel

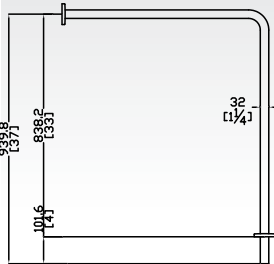

Wall to Floor Grab Bar with Outrigger

Specify left or right facing
DSGBFWLADA-ST5 (left)
DSGBFWRADA-ST5 (right)
34 9/16" height
Available in stainless steel; specify left or right facing

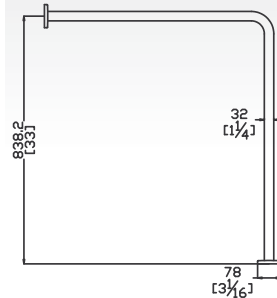

Horizontal/Vertical Grab Bar

Specify left or right facing
DSGBLL2ADA-ST5 (left)
DSGBLR2ADA-ST5 (right)
35 1/16" x 19 1/16"
Available in stainless steel; specify left or right facing

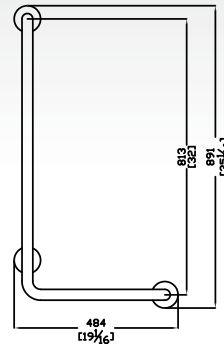

Straight Safety Support with Mid-Reinforce Mount (Wall to Wall)

DSGBFW52ADA-STN
55 1/16" height
Available in stainless steel



Horizontal Corner Grab Bar

DSGBCS4ADA-ST5
27 11/16" - 39 11/16" variable length
Available in stainless steel

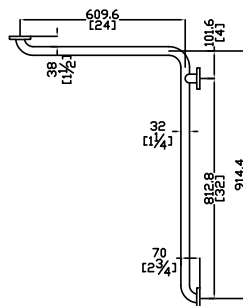

Straight Grab Bar

DSGB12ADA-STN
15 1/16" - 51 1/16" variable length
Available in stainless steel

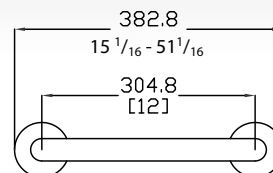

110° Angled Grab Bar

DSGBABADA
13 9/16" x 13 9/16"
Available in stainless steel

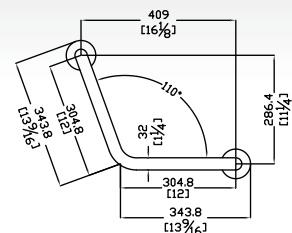

p. 242
What is BioPrism™

p.243
What is Lippert®

p. 244
Vertical Wall
Panels

p.246
Shower Bases

p. 250
Shower & Tub
Surrounds

p. 252
Decorative Panels

p. 254
Bath
Accessories

p.258
Vanity Tops

p. 260
Vainity Sink
Styles & Edges

p. 262
Countertop Sink
Styles & Edges

p. 263
Sheet Stock
Optimization

p. 264
Scratch & Stain
Resistance

p. 265
Custom
Fabrication

p. 266
Color Palette

p. 268
Accessories

Vanity Tops

| BIOPRISM™ SOLID SURFACE |



- Designed to fit your needs with standard straight tops or custom top styles such as banjos or bump-outs including mitre fold edges with integral aprons
- High performance solid surface sinks available (p.261)
- Decolav® stainless steel and Barclay® china undermount sinks available (p.261)
- To meet your own personal style, choose from various edge profiles (p.261)

Add a decorative element with an inlay available on the edge, around the sink or on the deck of the vanity top

Coved Backsplash Profile

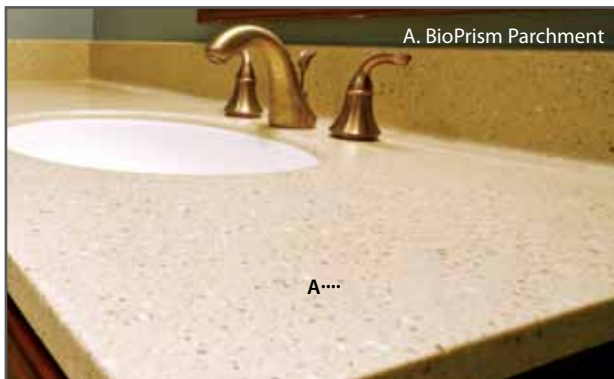
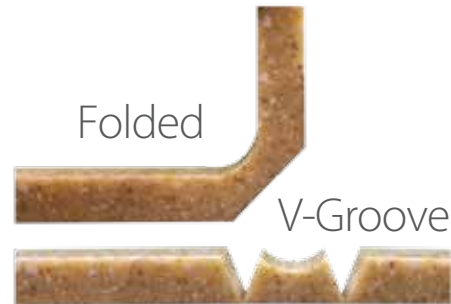

NEW! V-Groove Sheet

- Reduce labor and production costs by up to 65% with new V-Groove solid surfacing sheet option
- Ideal for front built-up edges and cove back splashes on countertop work stations and vanities
- Miter-folded surfaces allow for improved color consistency and overall enhanced appearance
- Available in all standard solid surfacing color options





Vanity Tops

| LIPPERT® CULTURED MARBLE |

- Standard or custom tops designed to fit your needs
- 4" covered backsplash standard. Detached backsplash and integral or detached sidesplash available (2 ¾" covered backsplash on 17" deep tops)
- Seven standard integral sink styles available (p.260)
- Four upgrade edge profiles to select (p.260)
- For easy installation, all standard cultured marble vanity tops have a scribe strip to ensure flush to the wall installations



Hand crafted, durable beauty that is easy to install and maintain.



A. Lippert Admiral

A....

Vanity Sink Styles & Edges



| LIPPERT® CULTURED MARBLE |

Optional overflow available on request, sinks fit 22" depth unless noted

Ovallav 1410 (014)

For use w/17" depth tops

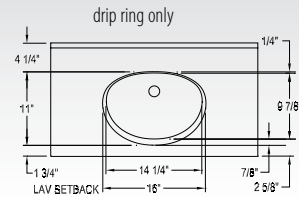

Ovallav 2000 (020)

For use w/19" depth tops

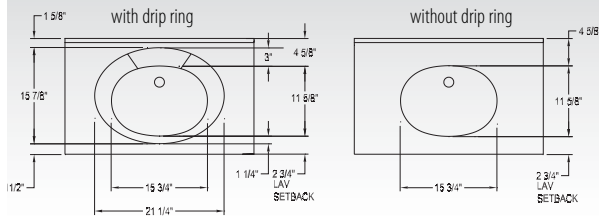

Ovallav 2300 (023)

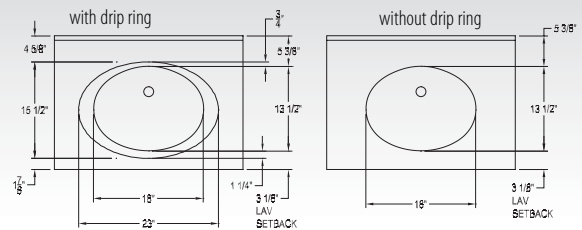

Shellav (SH)

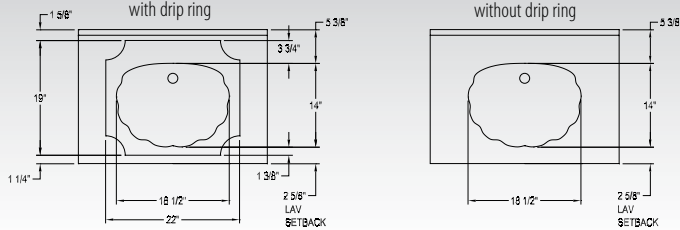

Naturelav (NL)

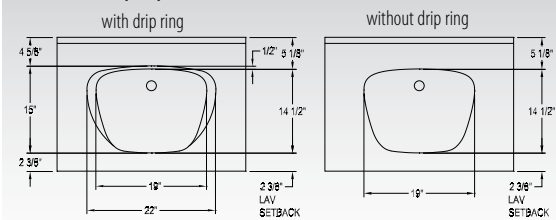

M400 (M4) Custom Only

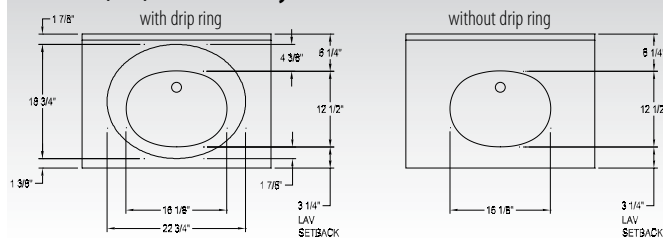

Aurora (AU)

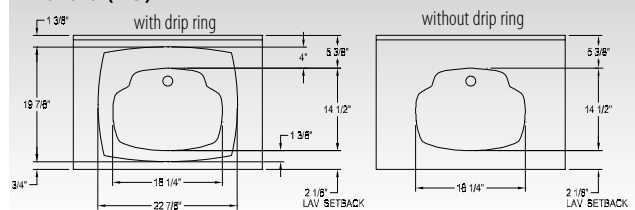

Lippert Undermount Sink Styles

Decolav® Stainless Steel
(Brushed/Polished)

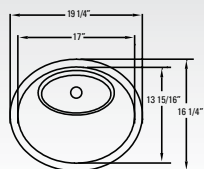

Barclay® China
(White/Bisque/Black)

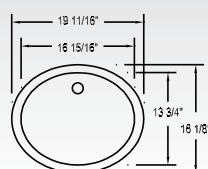

Lippert Vessel Sink

Lotus Lav

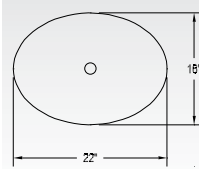

Lippert Upgrade Edge Treatments 1 1/2" Thickness

Standard edge is 3/4" thick eased

Thick Edge Radius Edge Bevel Edge Ogee Edge

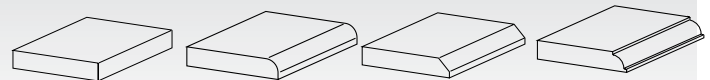

Decorative Surfaces

Vanity Sink Styles & Edges



| BIOPRISM™ SOLID SURFACE |

BioPrism™ Edge Types

Double Eased
1/8" radius

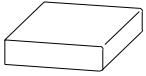

Double Radius
1/4" radius

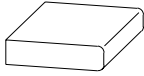

Bevel
1/4" bevel

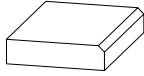

Double Bevel
1/4" bevel



Full Bullnose

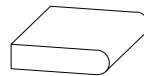

S-Curve



Classic Ogee



BioPrism™ Edge Types

Standard Edge: comes with perimeter pad of Medium Density Fiberboard. Ask about thicker edge options

Upgrade Edge: with edge inlay option

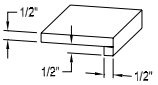

1" thickness

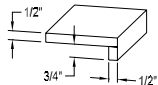

1 1/4" thickness

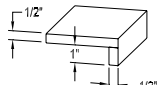

1 1/2" thickness

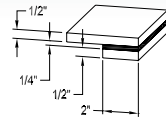

1 1/4" thickness
(Inlay Shown)

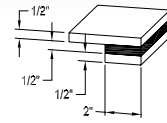

1 1/2" thickness
(Inlay Shown)

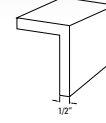

Flush Apron

Integral Sink Style - Enclosed Overflow Lav

Available in Bright White, White Sand, and Antique White only

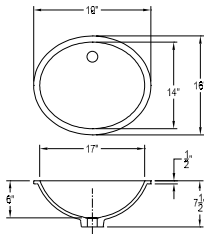

Undermount Sink Styles

Decolav® Stainless Steel
(Brushed/Polished)

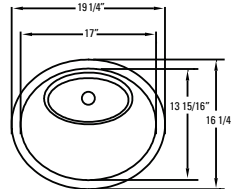

Barclay® China ■
(White/Bisque/Black)

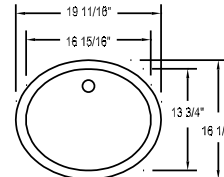

Vessel Sink Style

Round Vessel



Integral Sink Styles

Available in Bright White, White Sand, and Antique White only

QS Standard Lav ■

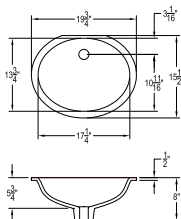

QS ADA Lav ■

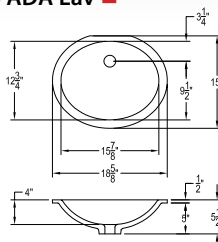

QS Small Lav

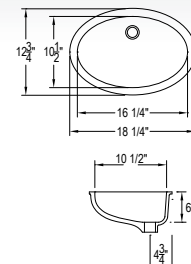

Countertop Sink Styles & Edges

| BIOPRISM™ SOLID SURFACE |

BioPrism Edge Treatments

Standard Edge: comes with perimeter pad of MDF

Upgrade Edge: with edge inlay option

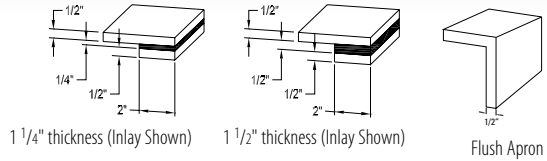
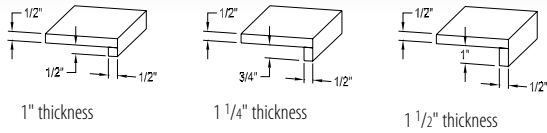

BioPrism™ Edge Treatments

Double Eased
1/8" radius

Double Radius
1/4" radius

Bevel
1/4" bevel

Double Bevel
1/4" bevel

Full Bullnose

S-Curve

Classic Ogee

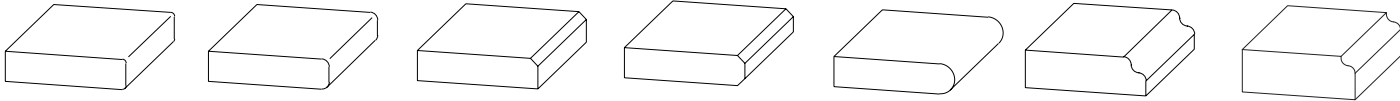

Integral Sink Styles

Available in Bright White, White Sand, and Antique White only

BioPrism™ Double Bowl

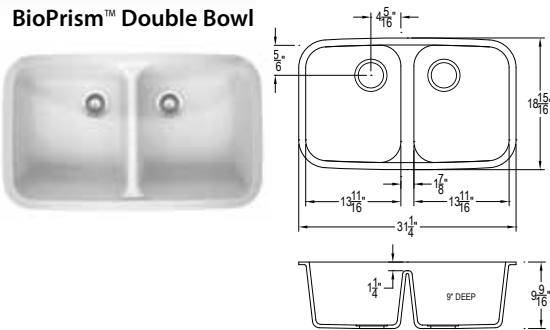

BioPrism™ Offset Bowl

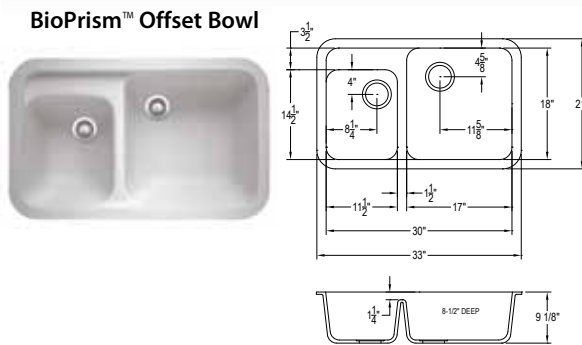

BioPrism™ Large Rectangle

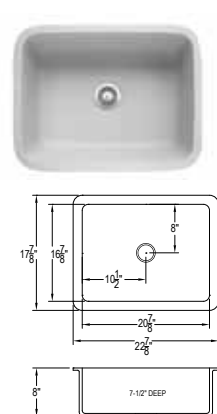

BioPrism™ Square Sink

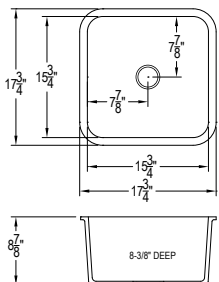

BioPrism™ Small Rectangle

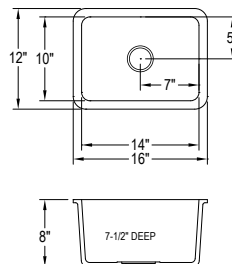

Decorative Surfaces

Sheet Stock & Optimization

| BIOPRISM™ SOLID SURFACE |

BioPrism™ Solid Surface

- Manufacturer-direct BioPrism Solid Surface sheets up to 48" x 144"
- Optimized sheet sizes reduce installation and labor costs for wall-cladding by covering more square footage per panel. Minimizing waste/scrap reduces not only project costs, and overhead costs
- Available in all colors in 1/4", and 1/2" thickness in matte/satin, semi-gloss or gloss finishes
- Optimized sheets are delivered manufacturer-direct to site and are wrapped in protective plastic for increased protection during transit (optional)

Standard Sizes:

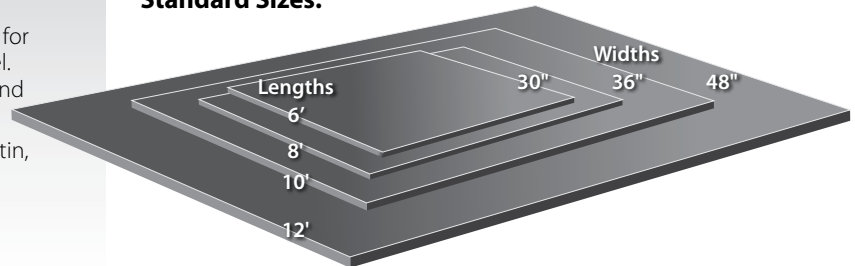

1/4" thickness

- 144" (12') x 30", 36", 48"
- 120" (10') x 30", 36", 48"
- 96" (8') x 30", 36", 48"
- 72" (6') x 30", 36", 48"

Can seam panels for additional width

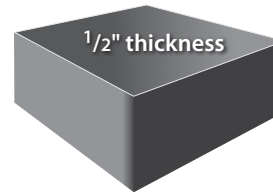

1/2" thickness

- 144" (12') x 30", 36", 48"
- 120" (10') x 30", 36", 48"
- 96" (8') x 30", 36", 48"
- 72" (6') x 30", 36", 48"

InPro will optimize your decorative surface needs with:

- Two thicknesses: 1/4", 1/2"
- Four lengths: 6', 8', 10', 12'
- Three widths: 30", 36", 48"
- All thicknesses, lengths and widths available in the complete BioPrism Solid Surface color palette!



Quick Ship Sheet!

36" x 144" x 1/2" and 48" x 96" x 1/4"
Max Quantity 5
Select colors available see p.52

Advantages of Sheet Optimization

- Less square footage of material purchased
- Custom sized sheets for your specific project
- Lower freight charges
- Optimized square footage per panel means less weight to ship
- Reduced labor costs
- Optimized square footage per panel means fewer field seams
- Covers more square footage faster, reducing installation cost & time
- Reducing scrap minimizes the impact of product waste on the environment, and lower refuse collection costs

Most Solid Surface products have a limited color offering depending on sheet size and thickness.

BioPrism™ Solid Surface stands apart from the competition by offering all colors in every sheet size and thickness.

Scratch & Stain Resistance

- BioPrism™ Solid Surface contains a proprietary blend of acrylic, polyester bio-resins, specially formulated for commercial environments offering the highest level of chemical resistance in a decorative surface
- Independently tested to withstand greater impact resistance than leading brands (izod impact, notched test)
- Factory finish on BioPrism solid colors is matte/satin for lighter colors, semi-gloss and all darker colors.

p. 242
What is BioPrism™

p.243
What is Lippert®

p. 244
Vertical Wall Panels

p.246
Shower Bases

p. 250
Shower & Tub Surrounds

p. 252
Decorative Panels

p. 254
Bath Accessories

p.258
Vanity Tops

p. 260
Vanity Sink Styles & Edges

p. 262
Countertop Sink Styles & Edges

p. 263
Sheet Stock Optimization

p. 264
Scratch & Stain Resistance

p. 265
Custom Fabrication

p. 266
Color Palette

p. 268
Accessories



- Start the sanding process with 60 micron. Use a 6" (152mm) or 8" (203mm) random orbital sander to improve sanding efficiency and uniformity



Betadine, Permanent Marker, Iodine, Acetone, Cigarette Lighter Burn, Ink Pen, Mercurochrome, Derma-Gel

- Reagents listed clockwise, beginning at top, were placed on product for 24 hours



- Sand with:
 - 60 micron paper
 - Scotch-Brite™ #7447 Maroon, Very Fine pad



- Scrubbed with water and Scotch-Brite™ #7447 Maroon, Very Fine pad



- Finish with:
 - Scotch-Brite™ #7448 Gray, Ultra Fine pad

Elapsed time: 47 seconds



- Dry with a paper towel

Elapsed time: 58 seconds

SOLID SURFACE VS. LAMINATE CONCERNS ABOUT BACTERIA AND MOLD GROWTH

SOLID SURFACE Does not promote the growth of mold, mildew or bacteria.

Integral bowl

Virtually seamless surface

Non-porous

LAMINATE Areas where bacteria may be found:

Sink Rims

Surface Seams

Delaminated, chipped or cracks in the laminate

Custom Fabrication

| BIOPRISM™ SOLID SURFACE |



BioPrism™ Solid Surface

- In conference rooms or dining areas, BioPrism tabletops combine a striking appearance with durability
- Incorporating BioPrism into a reception counter or nurse's station helps create an inviting, hygienic environment
- Create distinctive restrooms with solid surface panels
- Custom color available to match your existing decor. Or, engrave an attractive inlay or logo for a truly unique look
- All standard colors available in ¼", and ½" thicknesses; custom sheet sizes available up to 48" x 144". See p.263 for details on the BioPrism Solid Surface Sheet Optimization program!



Customize your Environment with a logo

Fabricator Training

| BIOPRISM™ SOLID SURFACE |



InPro provides in-house training to fabricators hand-selected based upon their commercial competence and market reputation. Fabricators attend a 2-day session held at the InPro solid surface manufacturing plant in New Berlin, Wisconsin. There, InPro equips them with the knowledge needed to transform BioPrism Solid Surface into fabricated products. Fabricators enjoy a wide range of benefits including a world-class sales support team, no distributor markup, and an estimating department to calculate the optimal quantity and sheet size for your job, thereby, limiting sheet waste and cost. Call InPro today to see how you can become part of the InPro fabricator network.

"Thanks so much for the wonderful training class on 'solid surfaces.' It was a great learning experience. [We] were pleased with the training. I would like to have a sample set of all of the colors sent to me. I am ready to try this product on a reception station that we're building now."

- Roy W. LeNeave Sr., Vice President - Engineering

Color Palettes

BioPrism™ Solid Surface

With an extensive color palette, InPro Decorative Surfaces has colors to complement your interior. Custom colors available for BioPrism Solid Surface; setup charges and minimum quantities apply.











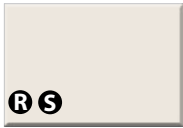
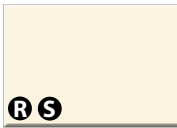
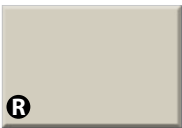

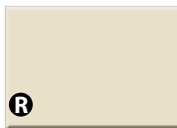
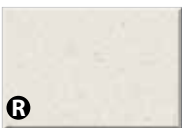
Available as signage, countertops, vanity tops, shower walls, tub surrounds, tub decks, window sills, wall panels, conference tables, and flat stock. The standard finish on light colors is satin while the finish on dark colors is semi-gloss. All colors available in 1/4", and 1/2" thickness.

BioPrism Solid Surface  BioPrism™ Receptor  BioPrism™ Sink



Quick Ship Colors

When you see a red ■ it means we have products in these colors on the shelf and ready to ship.

 Bright White P9011 ■ Price Class A	 White Sand P9002 ■ Price Class A	 Antique White P9001 ■ Price Class A
 Taupe P9005 ■ Price Class A	 Sandbar P9016 ■ Price Class B	 Buff P9071 ■ Price Class A
 Candlelight P9014 ■ Price Class B	 Trail P9031 ■ Price Class A	 Nougat P9069 ■ Price Class B
 Mahogany P9059 ■ Price Class B	 Snake Skin P9064 ■ Price Class B	 Coral Drift P9020 ■ Price Class B
 Curry P9045 ■ Price Class B	 Creole P9057 ■ Price Class B	 Portabella P9066 ■ Price Class B
 Admiral P9039 ■ Price Class B	 Chipotle P9021 ■ Price Class B	

InPro continues to support our prior color offerings for customers who have ongoing projects as well as new projects still in development. Please contact our sales team to discuss your design needs or unique requirements.

Standard Colors

 Glacier P9055 Price Class B	 Natural Linen P9079 Price Class B	 Milkyway P9056 Price Class B	 Fossil P9042 Price Class B
 Angora P9041 Price Class B	 Butternut P9072 Price Class B	 Macadamia P9046 Price Class B	 Terrazzo P9077 Price Class C
 Lunar P9013 Price Class B	 Sculpture P9076 Price Class B	 Parchment P9058 Price Class B	 Tumbleweed P9030 Price Class B
 Risotto P9043 Price Class B	 Mountain Mist P9022 Price Class B	 Haystack P9044 Price Class B	 Gravel P9054 Price Class B
 Dolomite P9019 Price Class B	 Breeze P9037 Price Class B	 Cosmic P9038 Price Class B	 Twilight P9040 Price Class B
 Raindrop P9034 Price Class B	 Gold Rush P9062 Price Class B	 Tea Leaf P9050 Price Class B	 Meteorite P9070 Price Class B
 Rouge P9026 Price Class B	 Galaxy P9025 Price Class B	 Everest P9065 Price Class B	



Due to the printing process, colors may vary. For more accurate color selection, please request samples. Color of final product may vary slightly from sample. Warranty excludes color variation from sample to final product. Dark colors may require additional maintenance.

Color Palettes

Lippert® Cultured Marble

Available as vanity tops, showers, tub surrounds, tub decks, wall panels and flat stock. Standard finish is gloss; satin finish available. Veining in our cultured marble is a custom process. Variance in veining patterns can be expected and is part of the natural beauty of material.

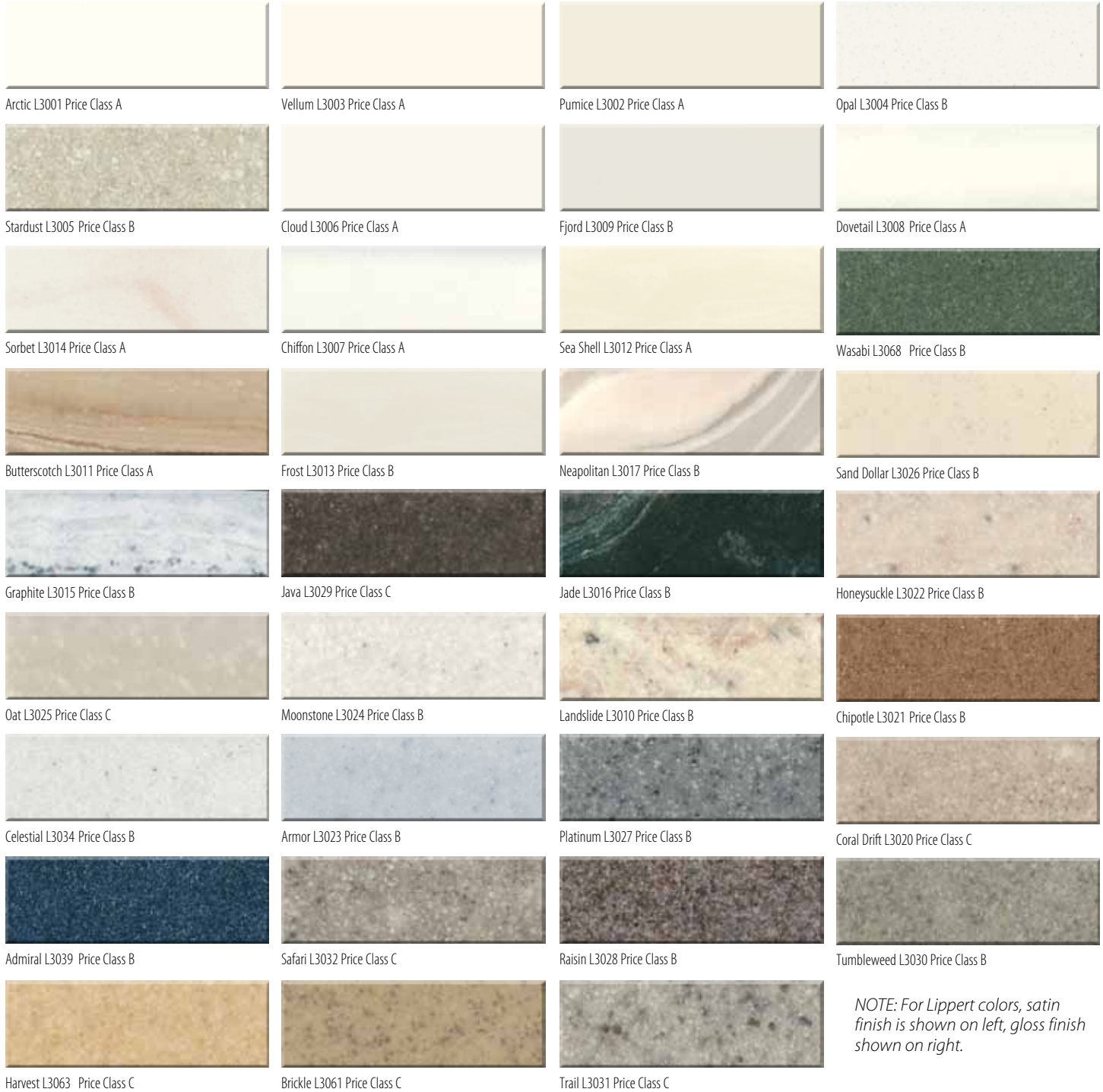

NOTE: For Lippert colors, satin finish is shown on left, gloss finish shown on right.



Due to the printing process, colors may vary. For more accurate color selection, please request samples. Color of final product may vary slightly from sample. Warranty excludes color variation from sample to final product. Dark colors may require additional maintenance.

Accessories, Tools & Adhesives



Scratch & Stain Resistance | Accessories, Tools & Adhesives



Stainless Steel L-Channel

Mark a level line locating wall studs and screw through L-channel. Channel supports shear weight of wall panels until adhesive takes hold.

Silicone sealant ■

Available in white or translucent white to adhere and seal solid surface and/or cultured marble



Granite FX

Sealant that is exclusively color-coordinated with the BioPrism color palette



Solid Surface Care Kit

Order a BioPrism care kit to maintain your solid surface.



Hard Seaming Gun

For use with all 250ml hard seaming solid surface adhesive.



Warranty / TERMS AND CONDITIONS

See inprocorp.com for warranty and terms and conditions information

Heat Conductive Tape

For use around cook tops and other cooking devices and hard to hold hard seaming applications.



Hard Seaming Material ■

Specifically formulated to match BioPrism color palette. 250ml bottle comes with 2 tips.



Scotch-Bright™ Pads ■

Maroon: a general purpose pad for matte finish solid surface.
White: a super-fine texture for high-gloss finish solid surface.
Gray: a fine sanding texture for semi-satin finish solid surface.



Mounting L-Brackets

Each pair of brackets hold up to 1,000 lbs. Perfect for mounting vanity tops when a cabinet is not used. Available in white. 159/16"L x 1039/64"H x 13/16"W

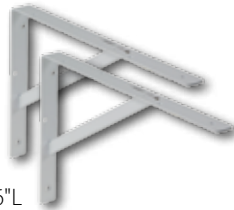

Hot Melt Gun and Sticks

The perfect adhesive applicator for construction sites, or where cords can get in the way!

Piezo Electronic Ignition, warms up in 3 minutes. Glue sold separately. Does not include Butane.



8" Vacuum Cup

125 lb. capacity per cup, vacuum leakage indicator with suction quick release button, includes protective carrying case.

